

Developing swimsuit Fabric using Nano-technology and screen photochemical method

Prof. Dr. Abd-El Raheem Ramadan

Head of Apparel Department, Faculty of Applied Arts, Helwan University, Egypt

Prof. Dr. Khaled El Nagar

Head of Chemical Metrology Div., National Institute for Standards, Egypt

Assist. Dr. Eman Raafat Saad

Lecturer Apparel Department, Faculty of Applied Arts, Helwan University, Egypt

Researrrcher. Eman Mohamed Ghanem

PhD student Apparel Department, Faculty of Applied Arts, Helwan University, Egypt

Abstract:

In this study, two ways were carried out in the polyester fabric, which used in traditional swimsuit manufacturing. Firstly the polyester fabric were coated with the silica nanoparticles to improve its functional properties for achieve the final use requirements. The characterization of silica nanoparticles on the fabric surface were done by using scanning electron microscope (SEM) and also on fabric surface before the treatment. Functional and Physical tests were accomplished. Those tests were weight, thickness, bursting Strength, stiffness, air permeability, water repellency. The properties of polyester fabric treated with the silica nanoparticles were compared with untreated polyester fabric. Secondly Sharkskin topography was used as guide for the changing the polyester fabric surface morphology and it was applied by photochemical method technique using Glycerol propoxylate triacrylate (HH-IV Water Resistant Diazo Emulsion) on the polyester fabric. The polyester fabric surfaces with photochemical technique, polyester fabric that treated with the silica nanoparticles and untreated polyester fabric were tested to measure its speed, with different weights on the water. The new polyester fabric surface may increase the efficiency of swimsuit.

Keywords: Nanotechnology, Silica nanoparticles, Nano textile coating, Sharkskin topography, photochemical technique.

المخلص:

في هذه الدراسة، تم تطبيق التقنية على نسيج البولي استر المستخدم في تصنيع ملابس السباحة التقليدية، أولاً تم تغطيه نسيج البوليستر مع الجسيمات النانوية السيليكا لتحسين خصائصه الوظيفية لتحقيق متطلبات الاستخدام النهائي. تم تصوير جسيمات السيليكا النانوية على سطح القماش المعالج وأيضاً تصوير سطح القماش الغير معالج باستخدام مجهر المسح الإلكتروني SEM وتم إجراء اختبارات معملية على النسيج المعالج وغير المعالج كانت تلك الاختبارات الوزن، سمك، قوة الانفجار، الصلابة، نفاذية الهواء ومقاومة المياه، تمت مقارنة خصائص نسيج البوليستر المعالجة بالنانو سيليكا مع نسيج البوليستر غير المعالج.

ثانياً تم استخدام طبوغرافية القرش كمرجع لتغيير مورفولوجيا سطح نسيج البوليستر وتم تطبيقه بتقنية التصوير الضوئي باستخدام (Glycerol propoxylate triacrylate) HH-IV Water Resistant Diazo Emulsion على أقمشة البولي استر وتم اختبار أسطح نسيج البوليستر مع تقنية التصوير الضوئي ونسيج البولي استر المعالج بجسيمات

النانو سيليكاتونسيج البولي استر الغير معالج لقياس سرعته بأوزان مختلفة في الماء. سطح قماش البولي استر الجديد من الممكن ان يزيد من كفاءة ملابس السباحة.

الكلمات المفتاحية: تقنية النانو، تجهيز المنسوجات، جسيمات النانو سيليكات (SiO₂NPs)، تغطيه الانسجة بالنانو، طبوغرافيا القرش، بتقنية التصوير الضوئي

1. Introduction

Swimming performance measured to the nearest 0.01 s, with swimmers in the top 16 of meets separated by only 0.10 s. Because drag is a major factor in the energetics of swimming, small decreases in the swimmer's drag can affect performance[1].

Swimming rapidity depends on the react between the hydrodynamic drag and propelling force[2]. Water repellent textiles, is repel water from the fabrics surface. Nonetheless, there are multiple methods which water can be repelled from the fabric surface[3]. The surface of fabric surface can repel water by absorption, resisting or penetration of water [4].

1.1 Nanotechnology

In the recent years nanotechnology has become one of the most exciting and important foreground fields in physics, biology, engineering and chemistry. It shows magnificent promise for providing us in the future with many penetration that will change the direction of advances technology in enormous range of applications. Nanotechnology deals with several structures of matter that have the distance of the order of a billionth of a meter [5]. Nanotechnology is a rapidly growing field that deals with the processing of materials with size less than 1000 nm, from the production to its applications [6].

a) Nanotechnology in Textiles

Hurriedly emerging nanotechnology offers improved and new ways of communicate a range of functional performance properties of fabrics textile. Now fact is that textile industry is the first manufacturing industry to come up with finished products that increased through nanotechnology based functional finishing. Nanotechnology also has revealed commercial potential for the textile industry. Because conventional methods used to impart different properties to fabrics often do not lead to permanent effects, and will lose their functions after wearing or laundering[7].

Nanotechnology can reduce the use of water as the nanostructure and surface functionality can be imparted using dry techniques on fabric [8].

Nanotechnology can provide fabrics high durability, because the nanoparticles have a large surface area-to-volume ratio and high surface energy, thus presenting better affinity for fabrics and leading to an increase in durability of the function. A coating of nanoparticles on fabrics will not affect mechanical and physical properties such as wetting, strength, and air permeability. Industry of Textile is the only major manufacturing industry that markets a range of products with a nanotechnology label attached to them [7].

b) Advantages of silica nanoparticles coating

- Easy handling
- non-toxicity

- Suitable for all textiles
- Harmless to skin
- Breathability remains
- Washing stable up to 40°C
- Long lasting care for textiles against water
- Dry cleaning resistant
- Simply wash off contaminants
- Long lasting sealing of textiles.
- Biocompatibility
- High surface area, pore volume
- Ability for surface charge control[10,11]

c) Integrated biomolecule nanoparticle systems

Biomolecules exhibit nanoscale dimensions analogous to the dimensions of nanoparticles (Figure 1)[9]. Revolutionary of nanotechnology and biotechnology have paved the way to complement these size similarities and intrinsic features of biomolecules with unique properties of nanoparticles to yield novel biomolecule-nanoparticle hybrid of synergistic characteristics and functions [12] Biomolecules also display several fundamental features that can be utilised as future building blocks for nanoparticle architecture. For example, the nature-evolved multiple binding sites of biomolecules in addition with its catalytic properties could facilitate the development of multifunctional nanoparticles [13]. Silica nanoparticles attract a great deal of attention as they are used in logic gates, memory devices, lightemitting devices, sensors, bio-imaging, energy storage, and textilefieldand photonic applications[7].

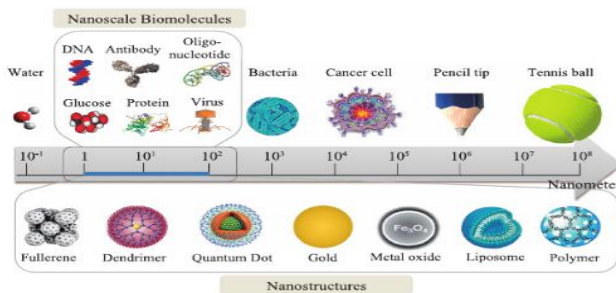

Figure 1 Nanoscale integration of nanoparticles and biomolecules [9]

1.2. Sharkskin structure

In recent decades, the skin of sharks has achieved a certain biomimetic status among both science popularizers and in research circles for the notion that the specialized skin surface structure could reduce drag and enhance the efficiency of locomotion. Manufactured body suits have been loosely modeled on shark skin with various ridges and dents, to induce surface roughness, that purportedly enhance swimming performance in humans, and researchers have long suspected that the special surface structure of shark skin contributes to the efficiency of locomotion shark skin Figure 2.[14] Although it might intuitively seem that a smooth surface will help minimize drag in swimming animals, a rough skin can actually be more effective in controlling flow over the body and reducing drag. A textured surface can

generate turbulence within the boundary layer region near the body surface. Although this turbulence increases the frictional drag, it infuses more energy into the boundary layer. The energy added by turbulence stabilizes the boundary layer by allowing it to overcome adverse pressure changes. The turbulent boundary layer is thus less likely to separate and increase the pressure drag. The same formation explains why golf balls with dimples travel faster and farther than smooth balls. The dimples cause turbulence near the ball surface and this increased energy delays flow separation and narrows the width of the wake [15].

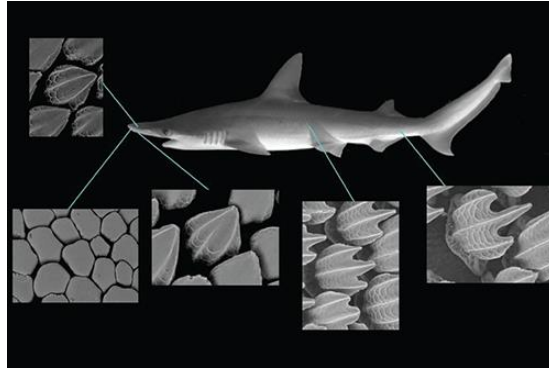

Figure 2 At different locations on a bonnethead shark (*Sphyrnatiburo*), the skin structure varies widely. Scanning electron micrographs of the skin scales.[15]

1.3. Screen Printing

Screen printing is relatively simple method of printing which can be carried out without the use of complicated and expensive equipment [16].

a)screen preparation

Photochemical method is most widely used for preparing the screen. This is based on the principle that when a coating of a solution of ammonium dichromate-gelatine on the dichromate-polyvinyl alcohol is dried and exposed to light, insolubilisation takes place other method for screen preparation is lacquer and laser screen.

b)Photochemical method

- Coat the flat screen with light-sensitive polymer, and dry it in the dark.
- Position a positive transparency of the pattern on the polymer-coated screen.
- Expose the screen to ultraviolet light, Ultraviolet light rays pass through the transparent (non-pattern) areas of the transparency on to the screen and harden the polymer.
- Wash the screen through which the printing paste will pass.
- Dry the screen Figure 3.

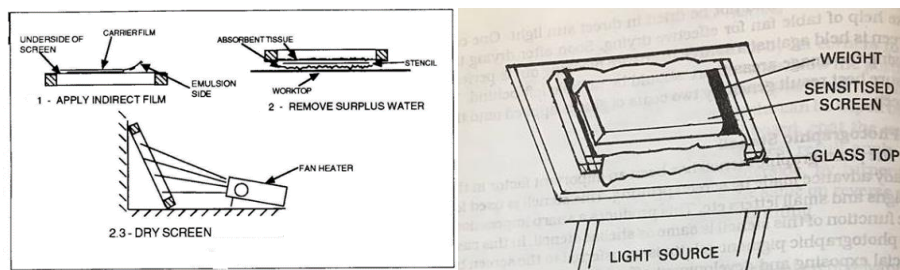

Figure 3 Screen preparation [17,18]

2. Experimental work

2.1. Fabric specification

- The fabrics used throughout this study are:

Polyester / Elastane blend (80/20%) it was obtained from AwladWahba Company for Textile, Table 1 showed their properties.

Table 1 Specification of fabrics

Fiber type	Weight (gm/m ²)	Thickness (mm)	Stiffness	Crease recovery
Polyester / elastane (80/20%)	350	0.63	49°	172°

2.2. Chemicals

a) Silica nanoparticles (SiO₂ NPs)

- Specifications:

Appearance: Clear liquid, Density: 1.1275g/ml, Hydroxyl value: 267 to 295 mg KOH/g, Physical form: clear colorless liquid, Formula Weight: 400.00 g/mol.

b) Glycerol propoxylatetriacrylate (HH-IV Water Resistant Diazo Emulsion)

- Properties:

Density: 1.064 g/mL at 25 °C(lit.), refractive index :n₂₀/D 1.461(lit.), contains: 300 ppm MEHQ as inhibitor.

2.3 Methodology

a) Silica nanoparticles coating

Personal precautions, protective equipment and emergency procedures, wear protective equipment. Keep unprotected persons away. Ensure adequate ventilation. Close-fitting safety goggles may be necessary in some circumstances to prevent eye contact with dust or fume.

Test samples were coated using silica nanoparticles (SiO₂ NPs) to improve its functional properties to satisfy the final use requirements.

-In the beginning the samples were washed thoroughly to remove any impurities attached to them before treatment and were left to dry in a horizontal position.

- The fabrics sprayed under tension by the liquor at each side then left to dry in a horizontal position after the first coating.

- We repeated coating the test sample three more times using the same technique.

b)Photochemical screen print

-Polyester fabric were washed thoroughly to remove any impurities attached to them before screen preparation and were left to dry in a horizontal position.

-Thepolyester fabric were stretched and fixed on the screen frame.

- The screen was coated onto the top surface, the emulsion polymer applied with a flat semi soft brush in a dark room, the screen is kept at 45° angle.

* Four screens were coated :

Two screens were coated with the Diazo Emulsion and the other two screens were coated with the Diazo Emulsion mixed with Silica nanoparticles.

-The screens were dried under a fan in a dark room.

- The positive painted pattern was placed in contact with the sensitized screen and exposed to the light.

* Sharkskin topography was used as guide to design positive painted pattern, Figure 5, 6

- The screens were washed clear in water and allowed to dry thoroughly.

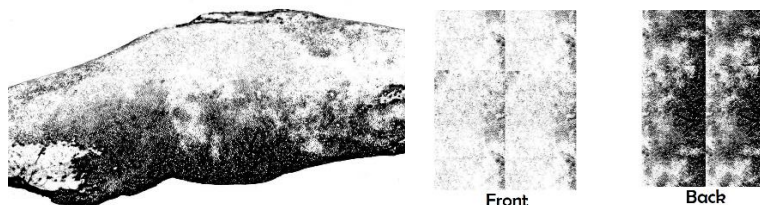

Figure 5 Sharkskin photocopy Figure 6 positive painted pattern

2.4 Experimental tests

a) Experimental tests

A number of tests, determining performance and function were used.

All tests were done in conditioned atmosphere of $20^{\circ}\text{C} \pm 2$ and $65\% \pm 2$ RH.

Average of three readings has been obtained for each property. Mass (Weight) obtained using digital sensitive scale according to (ASTM D3776-96-2003) [19]. Thickness obtained using thickness tester according to (ASTM D1777-96-2003) [20]. Air permeability test was carried out by using electronic air permeability tester according to (ASTM D737-86) [21], Bursting Strength obtained using Burst tester according to (ASTM D3787-16) [22], Stiffness obtained using stiffness tester according to (ASTM D1388) [23].

2.3.2 The speed test

The test device consisted of a framework placed in a swimming channel. In this framework a model of wooden cuboid attached with flexible plastic thread in the end of it we fix a weight Figure 7.

The position and length of the plastic thread was constant for each trial. Printing samples were applied to the wooden cuboid and once to a treated sample with silica nanoparticles and once to untreated sample.

Streaming body was used in exactly the same position (on water surface, horizontally centered in the swimming channel) for every test run.

Therefore, it can be assumed that differences in drag caused by surface friction were determined. Force was measured on water surface, parallel to the stream at five weight levels ranging from 50 to 250 gm.

*Six samples were tested as showed in table 2

Table 2 Types of fabrics that used in speed test

Sample code	Sp. 1	Sp.2	Sp. 3	Sp. 4	Sp. 5	Sp. 6
Sample type	Untreated Polyester	Polyester fiber treated with Silica nanoparticles	Diazo Emulsion front pattern	Diazo Emulsion back pattern	Diazo Emulsion mixed with Silica nanoparticles front pattern	Diazo Emulsion mixed with Silica nanoparticles back pattern

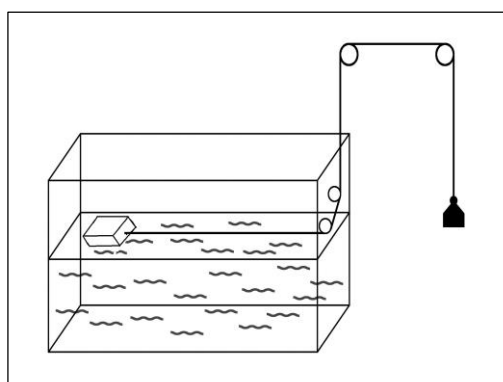

Figure 7 The speed test device.

The data was reviewed for normal distribution and standard deviation was calculated. In order to evaluate the speed of the prints at a certain weight or weight level, a ranking list was created for the average force at each weight level, for all weight levels and for all samples.

3. Results and discussion

3.1. Effect of silica nanoparticles (SiO₂ NPs) treatment on fabric surface

The surface morphology was identified by using Scanning Electron Microscope (SEM). It was notice that, the treated polyester fabrics with silica nanoparticles display the scaly appearance on the surface that made the surface rougher & enhance the water repellency. The water repellent agent forms an oily layer on the silica nanoparticles just like lotus leaves. Here silica nanoparticles act as an epidermal cells and water repellent agent as waxy bumps which results in superhydrophobicity on the polyester fabrics. Figure 8 shows, the SEM image of untreated Polyester fabric & figure 9 shows, the SEM image of Polyester fabric treated with silica nanoparticles.

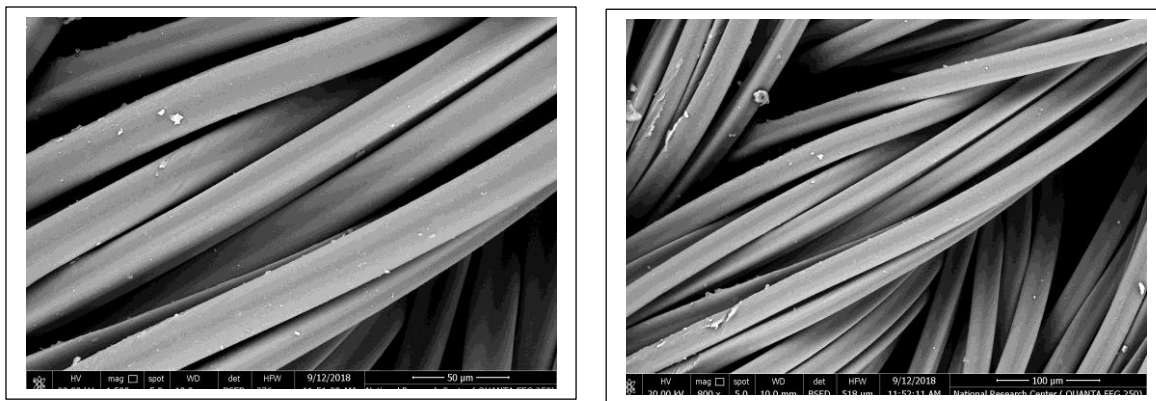
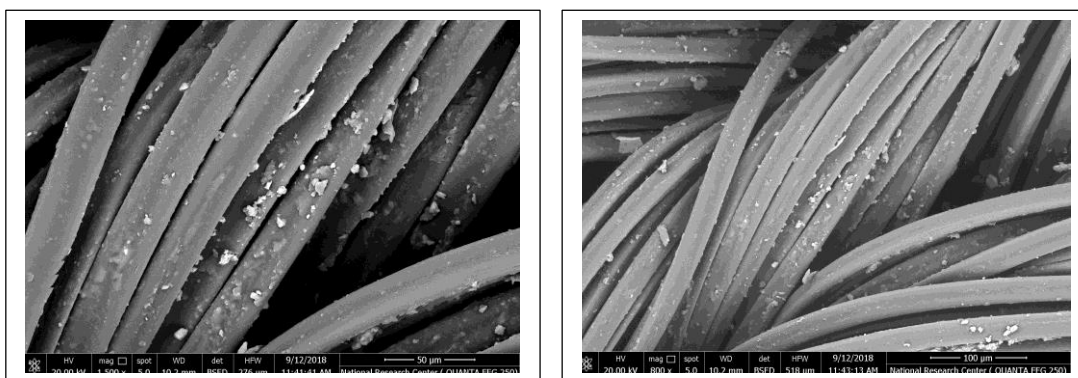

Figure (8) Scanning electron measurements(SEM) for the fabric before treatment



Figure(9) Scanning electron measurements(SEM) for the fabric after treatment

3.2. Effect of silica nanoparticles (SiO₂ NPs)treatment on fabricproperties

a) Effect of silica nanoparticles treatment on fabric weight

Table 3 Weight before and after treatment

Sample type	Weight (gm/m ²)	
	Before treatment	After treatment
80% polyester , 20% Elastane	350	358

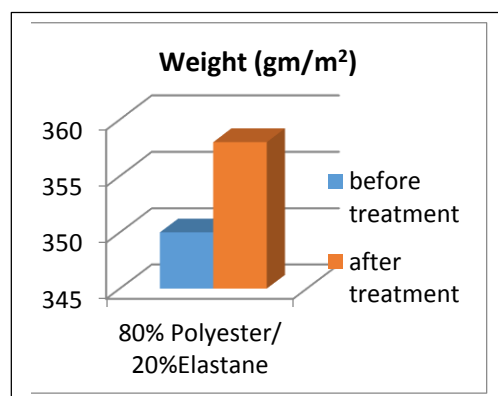

Figure 10 Weight before and after treatment

Table3 and figure 10displayed that fabric weight increases after treatment than before treatment this can be assign to the Nano particles that coated the fibers and penetrates them.

b) Effect of silica nanoparticle treatment on fabric thickness

Table 4 Thickness before and after treatment

Sample type	Thickness(mm)	
	Before treatment	After treatment
80% polyester , 20% Elastane	0.63	0.64

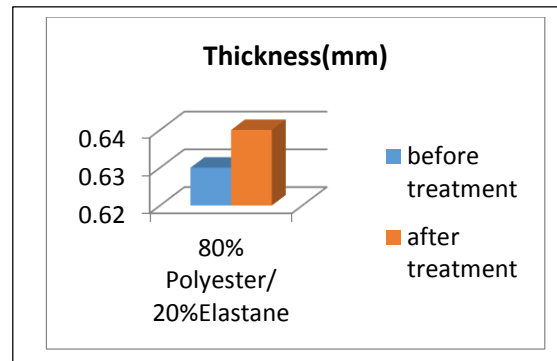

Figure 11 Thickness before and after treatment

As shown in table 4 and figure 11 thickness after treatment increases a little than before treatment this can be indicate to the very thin Nano film that is on the surface and around the fibers. This film is ulterior with a naked eyes the texture and look of fabric remains.

c) Effect of silica nanoparticle treatment on fabric Stiffness

Table 5 Stiffness before and after treatment

Sample type	Stiffness(mm)	
	Before treatment	After treatment
80% polyester , 20% Elastane	49°	47°

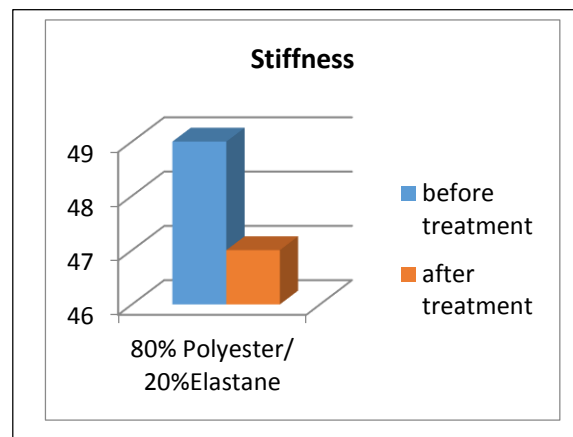

Figure 12 stiffness before and after treatment

As shown in table 5 and figure 12 stiffness after treatment decrease a little than before treatment this can be indicate to the very thin Nano film that is on the surface and around the fibers. This film is ulterior with a naked eye as the texture and look of fabric remains that make the fabric a little bit stiff after treatment.

d) Effect of silica nanoparticles treatment on fabric Bursting Strength

Table 6 Bursting Strength before and after treatment

Sample type	Bursting Strength (Kg/cm ²)	
	Before treatment	After treatment
80% polyester , 20% Elastane	7.0	7.4

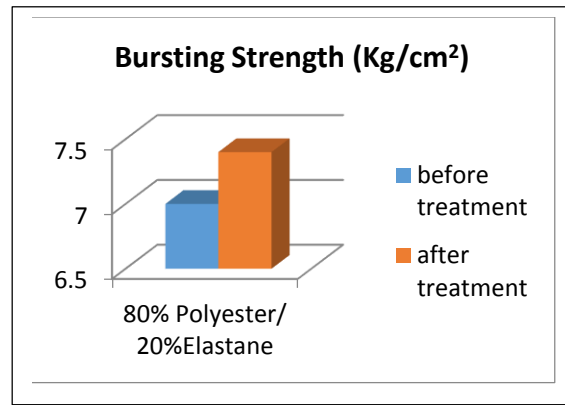

Figure 13 Bursting Strength before and after treatment

As shown in table 6 and figure 13 Bursting Strength after treatment increases This indicates that an increase in agent along with silica nanoparticles causes an increase in the resistance for the Bursting Strength of fibers.

e) Effect of silica nanoparticle treatment on fabric air permeability

Table 7 Air permeability before and after treatment

Sample type	Air permeability (cm ³ /cm ² .sec.)	
	Before treatment	After treatment
80% polyester, 20% Elastane	80.9	84

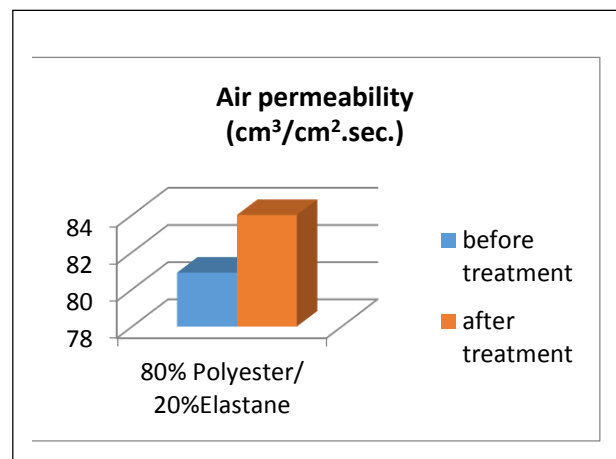

Figure 14 Air permeability before and after treatment

In spite of Nano film the surface of fabric coated with it, air permeability increases after treatment than before treatment, as shown in table 7 and figure 14 this shows that Nano treatment improves the breathability.

f) Effect of silica nanoparticles treatment on fabric Water repellency (contact angel)

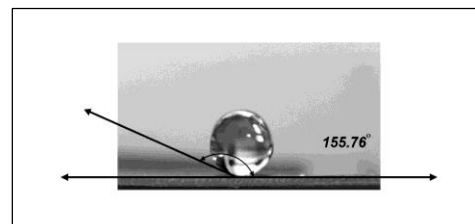
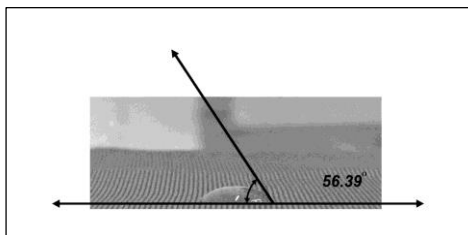

Figure 15 Contact angel before treatment Figure 16 Contact angel after treatment

Table 8 Water repellency before and after treatment

Sample type	Water repellency	
	Before treatment	After treatment
80% polyester, 20% Elastane	56.39°	155.76°

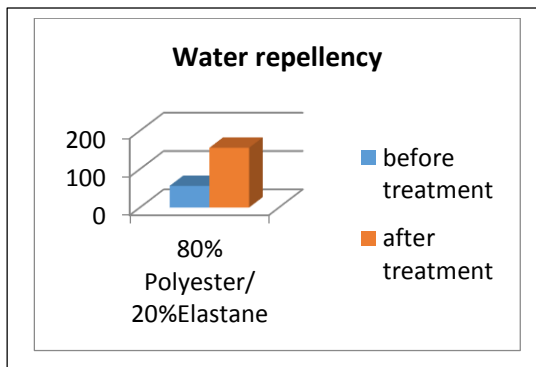

Figure (17) Water repellency before and after treatment

It's clear from table 8 and figure 17 that the treatment improves the water-repellent property of fabric. There was wetting for whole of upper and lower fabric surfaces before treatment while after treatment there is no sticking or wetting of upper surface. This makes polyester fabric superhydrophobicity. This can be assigned to the spaces between the fibers are smaller than the typical drop of water, but still larger than water molecules; water thus remains on the surface of the fabric.

3.3 Speed test results

Table 9 and Figure 18 show the calculated average speed for each sample at each applied load. The quadratic relation between weight and speed is displayed for all of the samples. Detailed information about the calculated forces at. These speed levels correspond with the lowest, the middle and the highest streaming velocities applied to the body.

Table 9 The samples test average speed

Speed Average						
Applied Load (g)	speed (cm/s)					
	Sp.1	Sp.2	Sp.3	Sp.4	Sp.5	Sp.6
50	6.56	6.38	7.32	7.27	6.83	6.4
100	4.67	4.23	5.45	5.12	4.9	4.62
150	3.72	3.45	5.09	4.6	3.78	3.54
200	3.18	2.95	4.01	3.7	3.64	3.05
250	2.5	2.32	2.71	2.69	2.59	2.38

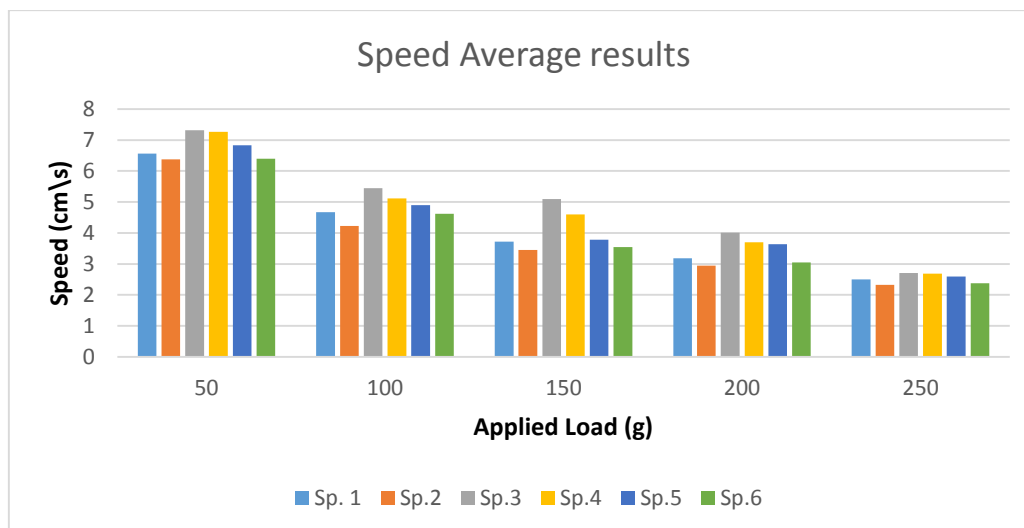

Figure 18The samples test average speed

From the results of the tests, we figured out that the sample Sp.2 (Polyester fiber treated with Silica nanoparticles) had the best speeds records in the test, thereaftersample Sp.6 (Diazo Emulsion mixed with Silica nanoparticles back pattern) and sample Sp.3 (Diazo Emulsion front pattern) had the worst speeds records in the test.

Conclusion

From the above results and discussion, It can be concluded that, in so far as SEM results are concerned polyester fabric traded with silica nanoparticles being more hydrophobic, Coating polyester fabrics with silica nanoparticles has a considerable effect on performance and functional properties, Coating polyester fabrics with silica nanoparticles has a significant effect on functional and performance properties, silica nanoparticles coating makes a very thin film that is invisible with a naked eye as the texture and look of fabric doesn't change after treatment, silica nanoparticles treatment makes fabric long lasting and more durable. Mix Diazo Emulsion with Silica nanoparticles improves its property.

References

- 1- <https://pdfs.semanticscholar.org/63a5/4bcc4b95c15154d5e0ac041f385394809f34.pdf> (accessed Sep 8 2017).
- 2- Marinho, D. A. et al., *Effect of Wearing a Swimsuit on Hydrodynamic Drag of Swimmer*, Braz. Arch. Biol. Technol. Volume 55 No 6, Nov/Dec 2012, pp. 851-856.
- 3- John W. Rowen et al., *Properties of Water-Repellent Fabrics*, Research Paper RP1762 Volume 38, January 1947, pp. 103-117.
- 4- Chinta S.K et al., *Synthesis and application of silica nanoparticles on polyester blended fabric to impart superhydrophobicity*, International Journal of Innovative Research in Science, Engineering and Technology Vol. 2, Issue 7, July 2013, pp.2882-2891.
- 5- Fouda Moustafa M. G., *Antibacterial Modification of Textiles Using Nanotechnology, A Search for Antibacterial Agents*.
- 6- Jaworek A., Sobczyk A.T., *Electrospraying route to nanotechnology: An overview*, Journal of Electrostatics, Volume 66 (2008) pp.197-219.

- 7- Kumar S Mahendra et al., *Synthesis and characterization of nano silicon and titanium nitride powders using atmospheric microwave plasma technique*, J. Chem. Sci. Volume 124, No. 3, May 2012, pp. 557–563.
- 8- Rezwana Mahmud et al., *Application of Nanotechnology in the field of Textile*, IOSR Journal of Polymer and Textile Engineering, Volume 4, No 1 ,Jan. - Feb. 2017, PP 01-06.
- 9- https://www.researchgate.net/publication/320132877_Nanoparticles_Carrying_Biological_Molecules_Recent_Advances_and_Applications(accessed Sep 16 2018).
- 10- Charu Bharti et al., *Mesoporous silica nanoparticles in target drug delivery system: A review*, Int J Pharm Investig, Volume 5 No 3, Jul-Sep 2015, pp124-133.
- 11- Saad Eman R. et al., *Effect of Coating with Silver Nanoparticles (AgNPs) on Cotton Fabric Functional Properties*, International Design Journal Volume 4 No 2, 2014, pp33-39.
- 12- Sperling R.A., et al., *Surface modification, functionalization and bioconjugation of colloidal inorganic nanoparticles*, Philosophical transactions Series A, Mathematical, physical, and engineering sciences, Volume 368 ,2010, pp. 1333–1383
- 13- Katz E., Willner I., *Integrated nanoparticle-biomolecule hybrid systems: Synthesis, properties, and applications*, Angewandte Chemie International Edition, Volume 43 ,2004, pp. 6042–6108.
- 14- Oeffner Johannes et al., *The hydrodynamic function of shark skin and two biomimetic applications*, The Journal of Experimental Biology Volume 215, 2012, pp.785-795.
- 15- <https://www.americanscientist.org/article/not-just-going-with-the-flow>(accessed Sep 11 2018).
- 16- Clarke W. et al., *An Introduction to Textile Printing*, Woodhead publishing limited, Cambridge, England, 2004
- 17- Siri Board of consultants & Engineers, *Handbook on screen printing-3rd edition*, Industrial project businesses of India.
- 18- [https://www.megaug.com/datasheets/5361_Introduction_to_Screen_Printing_\(1105\).pdf](https://www.megaug.com/datasheets/5361_Introduction_to_Screen_Printing_(1105).pdf)(accessed Sep 4 2018).
- 19- ASTM D3776-96-2003: Method of test for Mass (Weight).
- 20- ASTM D1777-96-2003: Method of test for thickness.
- 21- ASTM D737-86: Method of test for of Air Permeability.
- 22- ASTM D3787-16: Method of test for Bursting Strength of Textiles.
- 23- ASTM D1388: Method of test for the determination of stiffness.